

5601ACO2

Automatic Changeovers



The 5601ACO2 Automatic Changeovers are intended for use with two 5601MSC Master Clock/Sync Generators. The 5601ACO2 system uses latching relays to ensure maximum reliability and minimal disruption in the event of any failure. The complete system provides the highest level of security for television station video and time synchronization systems. The 5601ACO2 is a 2RU ACO for all outputs of the 5601MSC. Two power supplies are included as a standard feature, to alleviate any single point of failure concerns.

There are three switches behind the front panel for added security. There is an AUTO/MANUAL switch, a GPI/FRONT PANEL switch and an A/B select switch for manual changeover. In automatic mode, all signals from both 5601MSC are monitored to detect any abnormal signals. For example, if a level, pulse width, phase, time code error or other abnormality is detected, the 5601ACO2's circuitry will trigger and the entire bank of signals will be switched to the backup 5601MSC. In manual mode the changeover can be operated from a GPI or from the front panel switch. LEDs provide status information as to the health of the two 5601MSC, together with indication as to which one is active. In addition, two GPO outputs indicate which master is active and when the inputs from both masters are not the same.

The 5601ACO2 features selectable voting via VistaLINK® for autochangeover features. Individual inputs may selectively be included or excluded in the voting process to drive autochangeover logic (feature only available on 5601ACO2 and 5600ACO2 models).

Each 5601MSC is equipped with 2 GPI inputs and 2 GPO outputs. To facilitate installation, these connections are brought through to a 2x6 pin terminal block on the 5601ACO2. The outputs from the 5601MSC are passed straight through the 5601ACO2s. The inputs to the 5601MSC's are internally split by a 'Y' connector, to ensure that both 5601MSC's receive the same GPI contact closures.

In the event of a changeover occurrence, it is necessary that all outputs on one 5601MSC have the same timing as those on the other. Identical timing for both 5601MSC's is assured by locking both to the same frequency and phase source (e.g. GPS or by genlocking one 5601MSC to the other). Identical phasing of the independent black outputs is assured by implementing the "Syncro" mode in the 5601MSC's. To use this mode, both 5601MSC's syncro ports are connected together using the DB15 link cables supplied with the 5601ACO2. With both 5601MSC's operating in Syncro mode, timing adjustments made to one 5601MSC will be automatically applied to both. The link cable is connected permanently, so that any system re-timing will be applied to both 5601MSC units. (See system connection diagram on 5601MSC brochure).

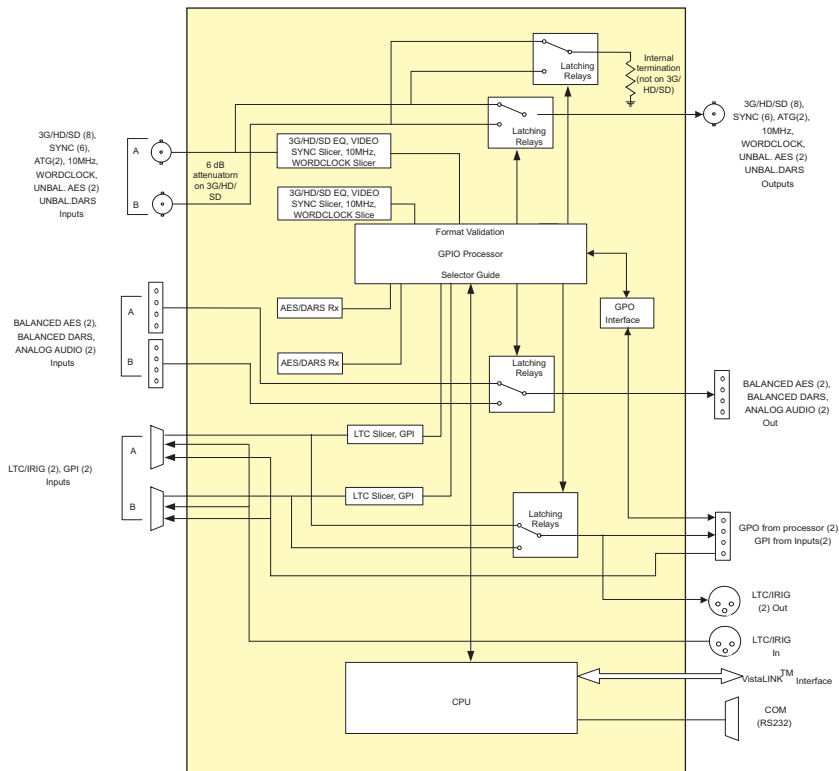

►Features & Benefits

- Three protected switches select automatic, front panel or GPI activation of changeover
- Front panel status LEDs show the health of each of the inputs
- Front panel status LEDs show the operational modes of the changeover
- Redundant power supply standard
- Push button to show cause of last changeover
- Dual hot swappable power supplied and fans
- Hot swappable main board
- GPIO input/outputs
- Automatic changeover is a voting system based on which source has the most valid signals and that the valid signals on the present master are also on the backup
- VistalINK® control for device configuration and status monitoring (5600ACO2 and 5601ACO2 only)
- 6 video/sync or other coaxial signals
- 10MHz frequency reference
- Word clock output
- DARS and 2 AES
- 2 Longitudinal (LTC/EBU) timecode outputs
- 8 SD/HD/3G outputs
- 2 Analog video test signal output

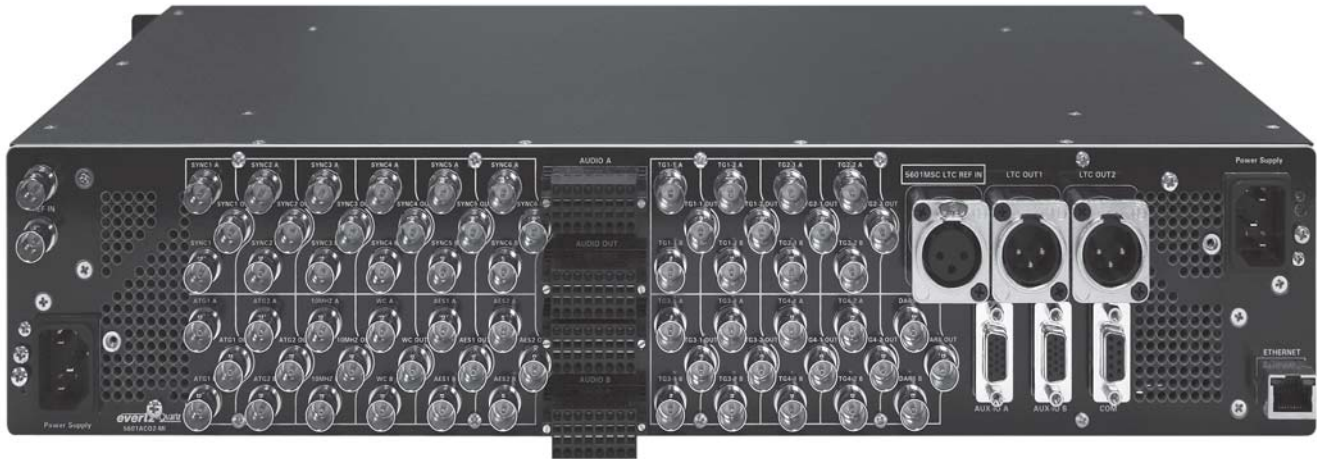

►Specifications

LTC/IRIG Inputs and Outputs:

Standard: SMPTE 12M-1 frame rate set by 5601MSC or IRIG-B
 Inputs: 2 per 5601MSC
 Outputs: 2
 Connectors:
 Inputs: Female DB15
 Outputs: 3-pin male XLR type
 Signal Level: Set in 5601MSC

Type:

Inputs: Opto-isolated input with internal pull-up to +5V
 Outputs: Normally closed relay to ground. 10kW internal pull-up to +5V when relay is in active position
 Connector: 4 pins plus 2 ground pins on 12-pin removable terminal block
 Signal Level: +5V nominal

Electrical:

Power: Auto ranging 100-240V AC, 50/60Hz, 40W
 Configuration: Dual redundant supplies
 Fuse Rating: 250V, 1 amp, time delay
 Safety: ETL Listed
 Complies with EU safety directives
 Complies with FCC Part 15 Class A
 Complies with EU EMC Directive

Coaxial Inputs and Outputs:

Type: Depends on signal connected from 5601MSC
 HD-SDI, SD-SDI, Analog TG, AES, DARS, bi-level or tri-level sync, colour black, 10MHz, Word Clock
 Number: 16 groups each consisting of two inputs and one output
 Connector: BNC per IEC 61169-8 Annex A

MSC General Purpose Inputs and Output:

Inputs: 2 GPI inputs connected to both Master A and Master B
 Outputs: 2 GPI outputs connected from Master A through AUXI/O A
 2 GPI outputs connected from Master B through AUXI/O B
 Connector: 6 pins on 12-pin removable terminal block
 Signal Level: As specified in 5601MSC manual

Physical:

Dimensions: 19" W x 3.5" H x 11.5" D.
 (483mm W x 90mm H x 292mm D)
 Weight: 16lbs (3.5kg)

ACO General Purpose Inputs and Output:

Inputs:
 GPI1: Master select in Manual GPI control mode
 Low: Selects Master A
 High: Selects Master B
 GPI2: Future use

Changeover conditions:

Changeover is a voting system based on which source has the most good signals and that the good signals on the current master are also present on the backup master. The input signals are considered good according to the following criteria:

Outputs:

GPO1: Low: Master A is selected
 High: Master B is selected
 GPO2: Low: Master A & Master B differ or PSU failure
 High: Master A and B have equivalent signals

Video: Level below 70 IRE
 Sync: H timing detect
 10MHz: 3dB level below 0.3V p-p
 DARS: Sync word error
 LTC: Level below 0.3V p-p
 Incorrect sync word

►Ordering Information

5601ACO2 2RU Automatic Changeover System complete with 2 power supplies, 2 power cords and 2 DB15 cables (BNC cables not included)